

Gas Appliance Pressure Regulators

FRS 7../6 Series FRS 5... Series

DUNGS®
Combustion Controls



CSA Certified

- ANSI Z21.18 / CSA 6.3 as a Gas Appliance Pressure Regulator
- File # 1205910

NPT Threaded Versions

- FRS 705/6 (1/2" NPT)
- FRS 707/6 (3/4" NPT)
- FRS 710/6 (1" NPT)
- FRS 712/6 (1 1/4" NPT)
- FRS 715/6 (1 1/2" NPT)
- FRS 720/6 (2" NPT)
- FRS 725/6 (2 1/2" NPT)
- FRS 730/6 (3" NPT)

ISO Flanged Versions

- FRS 5040 (1 1/2")
- FRS 5050 (2")
- FRS 5065 (2 1/2")
- FRS 5080 (3")
- FRS 5100 (4")
- FRS 5125 (5")
- FRS 5150 (6")

Commonwealth of Massachusetts Approved Product

- Approval code G1-1107-35
- Gas pressure regulator

Codes and Standards

This product is intended for installations covered by but not limited to NFPA 37, NFPA 86, NFPA 54, CSD-1, UL 795, ANSI Z83.4, ANSI Z83.18, ANSI Z21.13, CSA B149.1, CSA B149.3 and CSA B149.6.

DUNGS is an ISO 9001 manufacturing facility.



Description

The FRS 7../6 Threaded & FRS 5... Flanged balancing type pressure regulators are spring-loaded pressure regulators with an adjustable setpoint. Both feature an internal sensor for regulating output pressure.

- Input pressures up to 10 PSI (See specifications for more details) and NPT 1/2" to NPT 3" thread connections (FRS 7../6)
- Input pressures up to 7 PSI and DN 40 to DN 150 flanged connections (FRS 5... Flanged)
- Heavy duty diaphragm construction for durability and strength.
- Steady, precise and instantaneous regulation of the outlet pressure.
- Lock-up type regulator (see page 2 and 3 for details).

- Factory installed vent limiter. Review applicable codes for vent line requirements.

Application

The FRS series gas pressure regulators are recommended for industrial and commercial applications, and they are designed for high efficiency appliances, high-turn down appliances, appliances using direct spark ignition or hot surface ignition, and other applications requiring a high performance regulator. The FRS is suitable for dry natural gas, propane, butane, air and inert gases. The FRS does not contain any non-ferrous metals and is suitable for gases containing no more than 0.1 % by volume, dry H₂S. A "dry" gas has a dew point lower than +15 °F and its relative humidity is less than 60 %.

FRS Spring-loaded pressure regulator with adjustable setpoint spring. Internal sensor for regulating output pressure.

Specifications

Body size (FRS 7../6 threaded series) pipe size (Type NPT)	705/6 1/2"	707/6 3/4"	710/6 1"	712/6 1 1/4"	715/6 1 1/2"	720/6 2"	725/6 2 1/2"	730/6 3"
Body size (FRS 5...flanged series) pipe size (Type ISO welded flange)	5040 1-1/2"	5050 2"	5065 2-1/2"	5080 3"	5100 4"	5125 5"	5150 6"	
	Connection flange as per DIN 2501 Part 1: Fits preweld flanges as per DIN 2633 (PN 16) DN 40 to DN 150, per ISO 7085 - 1 (PN 16), or per ISO 7005 - 2 (PN 16)							
Max. inlet operating pressure FRS 7../6	7 PSI (500 mbar) at ambient +5 to +160 °F and outlet 4 - 80"WC. 5 PSI (350mbar) applies to CSA Certification.							
Max. inlet operating pressure FRS 5... Flanged	7 PSI (500 mbar) +5 °F to +150 °F (-15 °C to +70 °C) 5 PSI (350mbar) applies to CSA Certification							
Input pressure range for optimal control FRS 7../6	2 in. W.C. to 200 in. W.C. (5 mbar to 500 mbar)							
FRS 5... Flanged	2 in. W.C. to 200 in. W.C. (5 mbar to 500 mbar)							
Max. body pressure FRS 7../6	15 PSI (1000 mbar)							
FRS 5... Flanged	10 PSI (700 mbar)							
Output pressure range	1 in. W.C. to 80 in. W.C. (2.5 mbar to 200 mbar). See spring selection below.							
Materials in contact with gas	Housing:				Aluminum, steel (free of non-ferrous metals)			
	Seals and diaphragms:				NBR-based rubber			
Ambient temperature FRS 7../6	+5 °F to +160 °F for up to 10 PSI for regulating behavior (+/- 10% of setpoint). -40 °F to +160 °F for up to 5 PSI: Diaphragms are suitable for the low temperature, but there may be out of range regulating behavior. CSA Certified for -40 °F to +160 °F for up to 5 PSI.							
Ambient temperature FRS 5... Flanged	+5 °F to +150 °F for up to 7 PSI (-15 °C to +70 °C)							
Installation position	Regulator dome from vertically upright to lying horizontally							
Vent line connection / vent limiter	Vent line connection is G 1/4" for FRS's up to 1" NPT, and it is G 1/2" for FRS's 1 1/4 to 3" NPT. The FRS also has a factory installed vent limiter, which limits the escape of gas to less than 0.5 CFH @ 5 PSI in case atmospheric diaphragm ruptures. Venting required unless otherwise accepted by the authority having jurisdiction.							
Turndown	Rated for 20:1							
Hysteresis and Droop	Hysteresis/repeatability is less than 10% for up to 7 PSI inlet. Average droop at 20:1 turndown is 10% for up to 7 PSI.							
Lock-up Rating	<ul style="list-style-type: none"> • The FRS meets the ANSI Z.21.80/CSA 6.22 as Class I, which allows lockup rating not more than 150% or 5 in. W.C, whichever is greater. • The FRS meets EN 88 as SG30, which allows lock-up as high as +30% of the outlet pressure. • See Lock-up pressure parameters on page 3 for more details 							

Lock-up Rating Parameters

Per ANSI Z21.80, lock-up is defined as an outlet pressure not more than 150 % or 5 in. W.C, whichever is greater, above the setpoint after a downstream safety shutoff valve closes with 2 seconds, and the two following conditions exists:

- 1) outlet pressure is set to the highest set point of the spring, and
- 2) the regulator is set to maximum capacity or flow at which the regulator will control lockup pressure within the acceptable limits.

This means that in a given application, a lockup greater than 150 % or 5 in. W.C could occur, depending out the

inlet pressure, the outlet pressure of the regulator, the flow rate of the regulator, and the pipe volume downstream the regulator and upstream the safety shutoff valve.

Per EN 88, lock-up is +30 % of the outlet pressure setting after downstream shutoff valve slowly closes within 30 seconds. Therefore, in a given application, a lockup greater than +30 % or 5 in. W.C could occur, depending out the inlet pressure, the outlet pressure of the regulator, the flow rate of the regulator, and the pipe volume downstream the regulator and upstream the safety shutoff valve.

If in a given application the Lock-up pressure is too high, imploring one or more of the following should reduce the lock-up pressure:

- 1) increase the size of the regulator.
- 2) increase the pipe volume downstream the regulator and upstream the safety shutoff valve.
- 3) decrease the inlet pressure.
- 4) decrease the outlet pressure.
- 5) reduce the flow rate.

Outlet Pressure Spring Selection (outlet pressure values are for horizontal pipe mounting)

The output pressure is controlled by the force of the adjustable spring. The pressure regulator is supplied with the blue spring No. 4. By exchanging springs, other output pressures can be attained. Subtract 1"W.C. when mounted vertically.

Spring Range (W.C.) Spring color	1 to 3.6 brown Not CSA	2 to 5 white	2.8 to 8 orange	4 to 12 blue Standard	10 to 22 red	12 to 28 yellow	24 to 40 black	40 to 60 pink	60 to 80 grey Not CSA
FRS 705/6	229-817	229-818	229-820	229-821	229-822	229-823	229-824	229-825	229-826
FRS 707/6	229-833	229-834	229-835	229-836	229-837	229-838	229-839	229-840	229-841
FRS 710/6	229-842	229-843	229-844	229-845	229-846	229-847	229-848	229-849	229-850
FRS 712/6, 715/6, 5040	229-851	229-852	229-853	229-854	229-869	229-870	229-871	229-872	229-873
FRS 720/6 & 5050	229-874	229-875	229-876	229-877	229-878	229-879	229-880	229-881	229-882
FRS 725/6, 730/6, 5065, 5080	229-883	229-884	229-885	229-886	229-887	229-888	229-889	229-890	229-891
FRS 5100	229-892	229-893	229-894	229-895	229-896	229-897	229-898	229-899	229-900
FRS 5125	229-901	229-902	229-903	229-904	229-905	229-906	229-907	229-908	243-416
FRS 5150	229-909	229-910	229-911	229-912	229-913	229-914	229-915	229-916	243-417

Pressure Taps - FRS 7../6 Threaded Version

- 1 Vent/breather connection
FRS 705/6 - FRS 710/6, G 1/4 in.
FRS 712/6 - FRS 730/6, G 1/2 in.
- 2 External feedback pressure connection
FRS 705/6 - FRS 710/6, G 1/4 in. - one side.
FRS 712/6 - FRS 730/6, G 1/4 in. - both sides.
- 3 Upstream pressure connection
FRS 705/6 - FRS 710/6, 1/4 in. NPT - one side.
FRS 705/6 - FRS 710/6, G 1/4 in. - one side.
FRS 712/6 - FRS 730/6, 1/4 in. NPT - both sides.
- 4 Downstream pressure connection
FRS 705/6 - FRS 710/6, 1/4 in. NPT - one side.
FRS 712/6 - FRS 730/6 1/4 in. NPT - both sides.

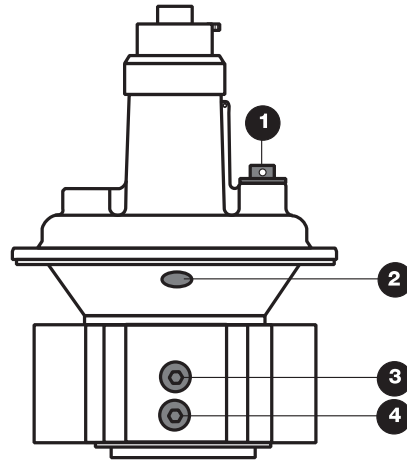

Pressure Taps - FRS 5... Flanged Version

FRS Flanged

- 1 Vent/breather connection
FRS 5040 - FRS 5150, G 1/2 in.
- 2 External feedback pressure connection
FRS 5040 - FRS 5150, both sides G 1/4 in.
See caution below.
- 3 Upstream pressure connection
FRS 5040 - FRS 5150, both sides G 1/4 in.

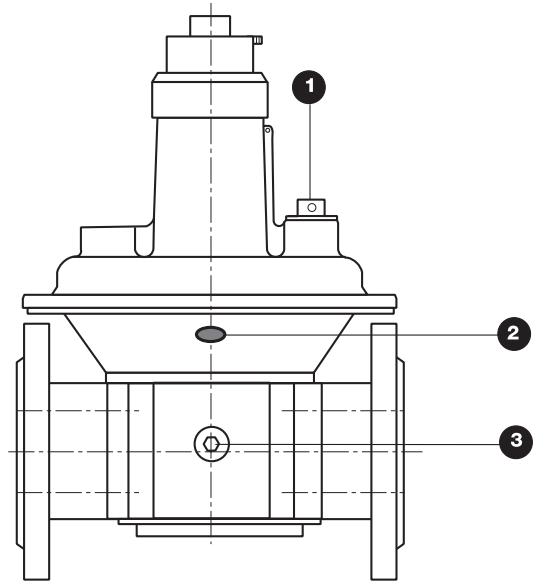

 When using external feedback pressure connection, the internal feedback tube must be sealed with RTV.

FRS Flange Accessories

Size	Weld neck part #	# of bolts/connection	Bolt size	**Bolt part #	***Seal part #
DN ISO 40	227-137	4	M16x55	135-940	100-164
DN ISO 50	227-138	4	M16x55	135-940	030-221
DN ISO 65	227-139	4	M16x65	135-930	099-408
DN ISO 80	227-140	8	M16x65	135-930	030-254
DN ISO 100	227-141	8	M16x65	135-930	030-304
DN ISO 125	227-142	8	M16x75	148-830	030-312
DN ISO 150	227-143	8	M20x80	135-950	030-403
DN 65 to 2 1/2"NPT	243-690	4	M16x65	135-930	099-408
DN 80 to 3"NPT	243-219	8	M16x65	135-930	030-254

* When a control is used alone, one mating flange is needed for each end, for a total of two flanges. When one control is bolted to another, such as an FRS to a DMV dual modular safety valve, one mating flange is needed for each end, for a total of two flanges.

** Includes one bolt, one lock washer, and one nut.

*** One seal needed for each flange.

FRS 7../6 Dimensions inch (mm)

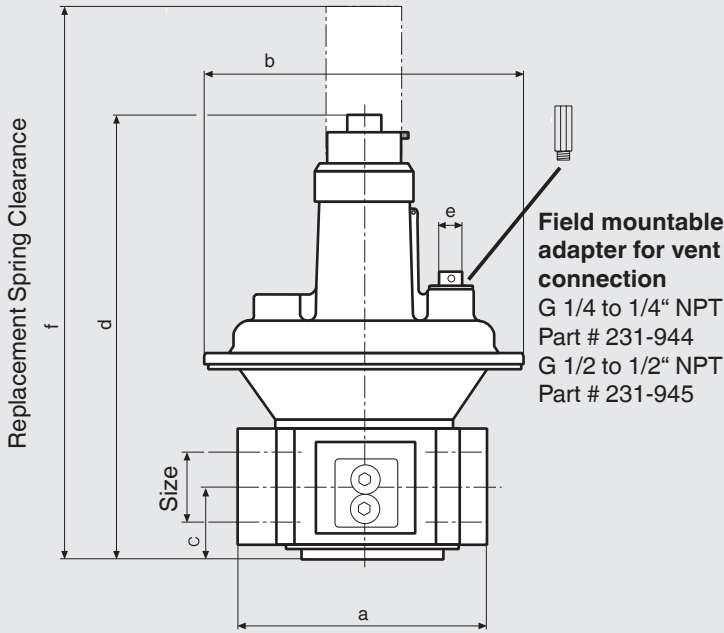

FRS 5... Flanged Dimensions inch (mm)

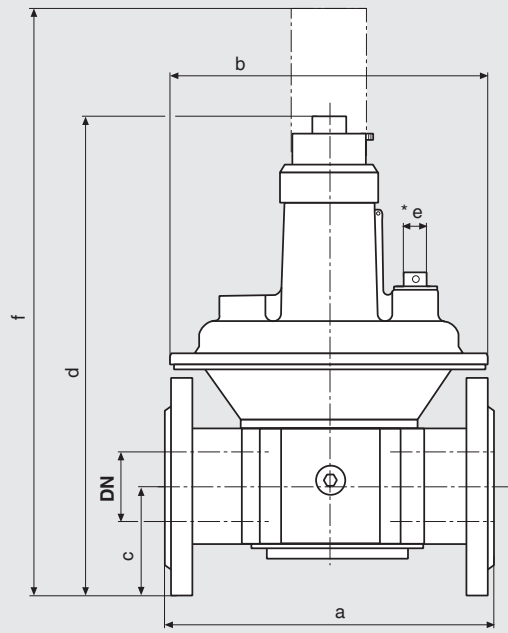



FRS 7../6 Threaded Type	Order No.	Pressure _{max.} [PSI]	Size	Dimensions [inch] Dimensions [mm]						Weight [lbs] [kg]
				a	b	c	d	e	f	
FRS 705/6	229-595	see specification on page 2	NPT 1/2	2.9 75	4.5 115	0.9 24	5.6 143	G 1/4	8.9 225	1.3 0.6
FRS 707/6	229-608	see specification on page 2	NPT 3/4	3.9 100	5.1 130	1.1 28	6.5 165	G 1/4	9.6 245	2.2 1.0
FRS 710/6	229-609	see specification on page 2	NPT 1	4.3 110	5.7 145	1.3 6	7.5 190	G 1/4	12.2 310	2.6 1.2
FRS 712/6	229-610	see specification on page 2	NPT 1 1/4	5.9 150	7.7 195	1.6 40	9.8 250	G 1/2	14.2 365	5.9 2.7
FRS 715/6	229-611	see specification on page 2	NPT 1 1/2	5.9 150	7.7 195	1.6 40	9.8 250	G 1/2	14.2 365	5.5 2.5
FRS 720/6	229-612	see specification on page 2	NPT 2	6.7 170	9.8 250	1.9 47	12.2 310	G 1/2	17.7 450	7.7 3.5
FRS 725/6	229-613	see specification on page 2	NPT 2 1/2	9.1 230	11.2 285	3.7 95	15.9 405	G 1/2	23.2 590	16.5 7.5
FRS 730/6	229-614	see specification on page 2	NPT 3	10.4 265	11.2 285	3.7 95	15.9 405	G 1/2	23.2 590	22.0 10.0

FRS 5... Flanged Type	Order No.	Pressure _{max.} [PSI]	Size	Dimensions [inch] Dimensions [mm]						Weight [lbs] [kg]
				a	b	c	d	e	f	
FRS 5040	065-144	7	DN 40 (1 1/2")	7.9 200	7.7 195	2.6 65	11.0 280	G 1/2	15.6 395	7.7 3.5
FRS 5050	065-151	7	DN 50 (2")	9.1 230	9.9 250	3.0 75	13.4 340	G 1/2	18.9 480	11.0 5.0
FRS 5065	058-792	7	DN 65 (2 1/2")	11.4 290	11.2 285	3.7 95	16.0 405	G 1/2	23.2 590	16.5 7.5
FRS 5080	079-681	7	DN 80 (3")	12.2 310	11.2 285	3.7 95	16.0 405	G 1/2	23.2 590	22.1 10.0
FRS 5100	082-552	7	DN 100 (4")	13.8 350	13.8 350	4.1 105	19.5 495	G 1/2	29.9 760	35.3 16.0
FRS 5125	013-250	7	DN 125 (5")	15.8 400	15.8 400	5.3 135	25.0 635	G 1/2	39.4 1000	61.7 28.0
FRS 5150	013-268	7	DN 150 (6")	18.9 480	18.9 480	6.3 160	30.7 780	G 1/2	46.5 1180	83.8 38.0

FRS 7../6 sectional drawing
Pressure regulator in operating position

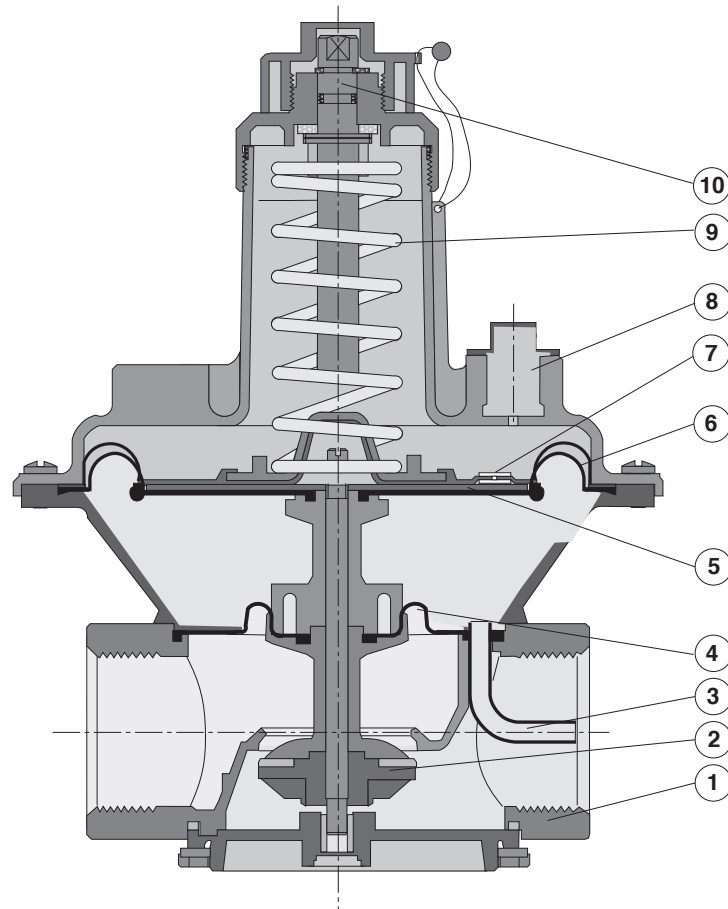
- 1 Housing
- 2 Regulating cup
- 3 Internal feedback tube
- 4 Balancing diaphragm
- 5 Diaphragm disk
- 6 Atmospheric diaphragm
- 7 Vent limiter
- 8 Vent line connection
- 9 Setpoint spring
- 10 Adjustment device



 **Protect the pressure regulator from debris by using a suitable filter.**

Pressure drop for other gases

To determine the pressure drop when using a gas other than natural gas, use the flow formula below and f value located in the table below to determine

the “corrected” flow rate in CFH through the valve for the other gas used. For example, when using propane, divide the volume (CFH) of propane required for the application by the calculated value

f (f = 0.66 for propane). Use this “corrected” flow rate and the flow curve on the next page to determine pressure drop for propane.

Determining equivalent flow through valves using another gas

$$\dot{V}_{\text{gas used}} = \dot{V}_{\text{Natural gas}} \times f$$

$$f = \sqrt{\frac{\text{Density of Natural gas}}{\text{Density of gas used}}}$$

Type of gas	Density [kg/m ³]	s.g.	f
Natural gas	0.81	0.65	1.24
Butane	2.39	1.95	0.58
Propane	1.86	1.50	0.66
Air	1.24	1.00	1.00

Mechanically Opened Curve

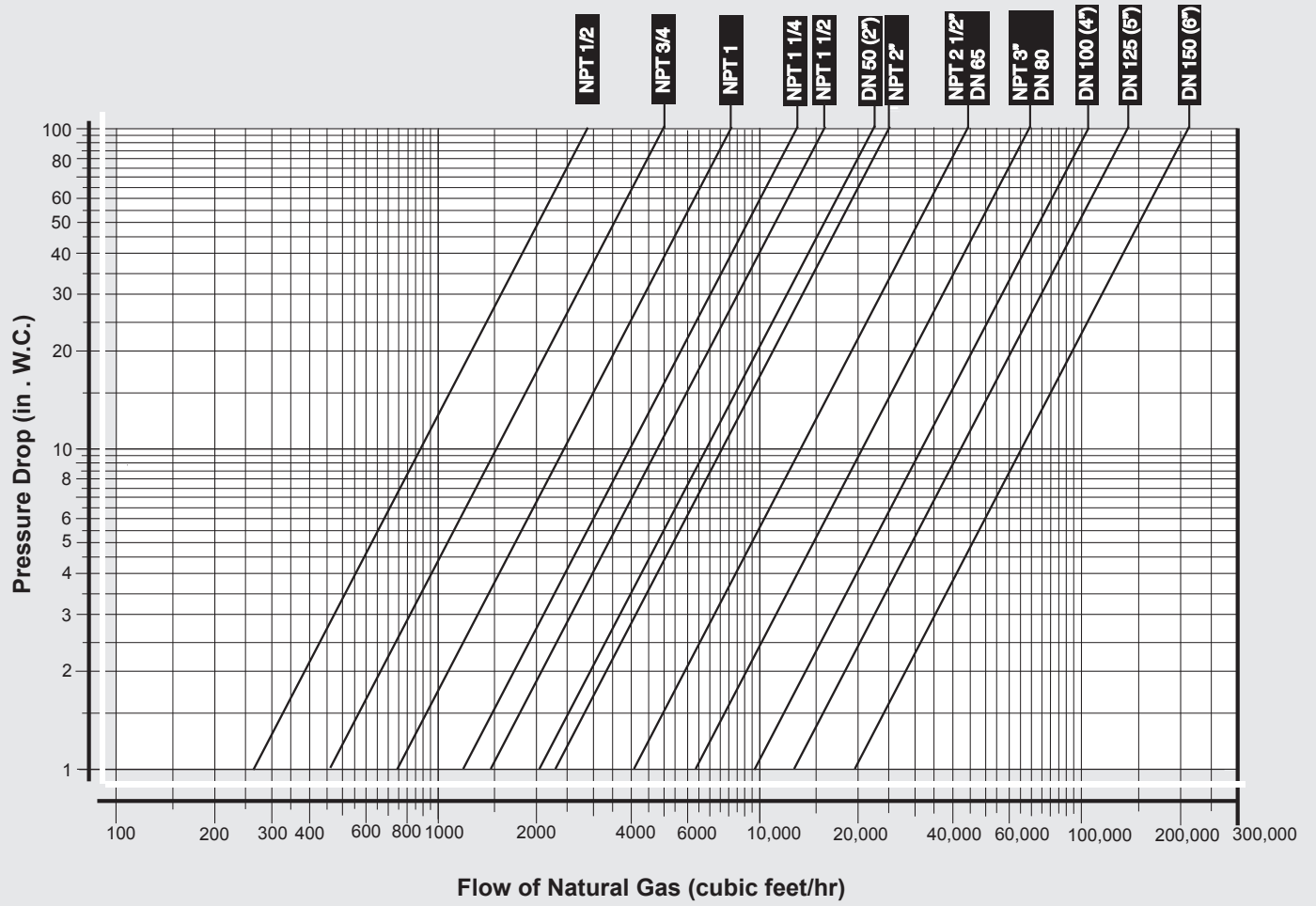

Gas Appliance Pressure Regulators

FRS 7.../6 Series
FRS 5... Series



Flow Curve Using Natural Gas.

Use as a quick reference for sizing a regulator in the regulated state at:

Outlet pressure = 8 in. W.C.

Inlet pressure = 20 in. W.C.

$V_{min} = 0.05 \times V_{max}$

Flow tables for other outlet pressures are available

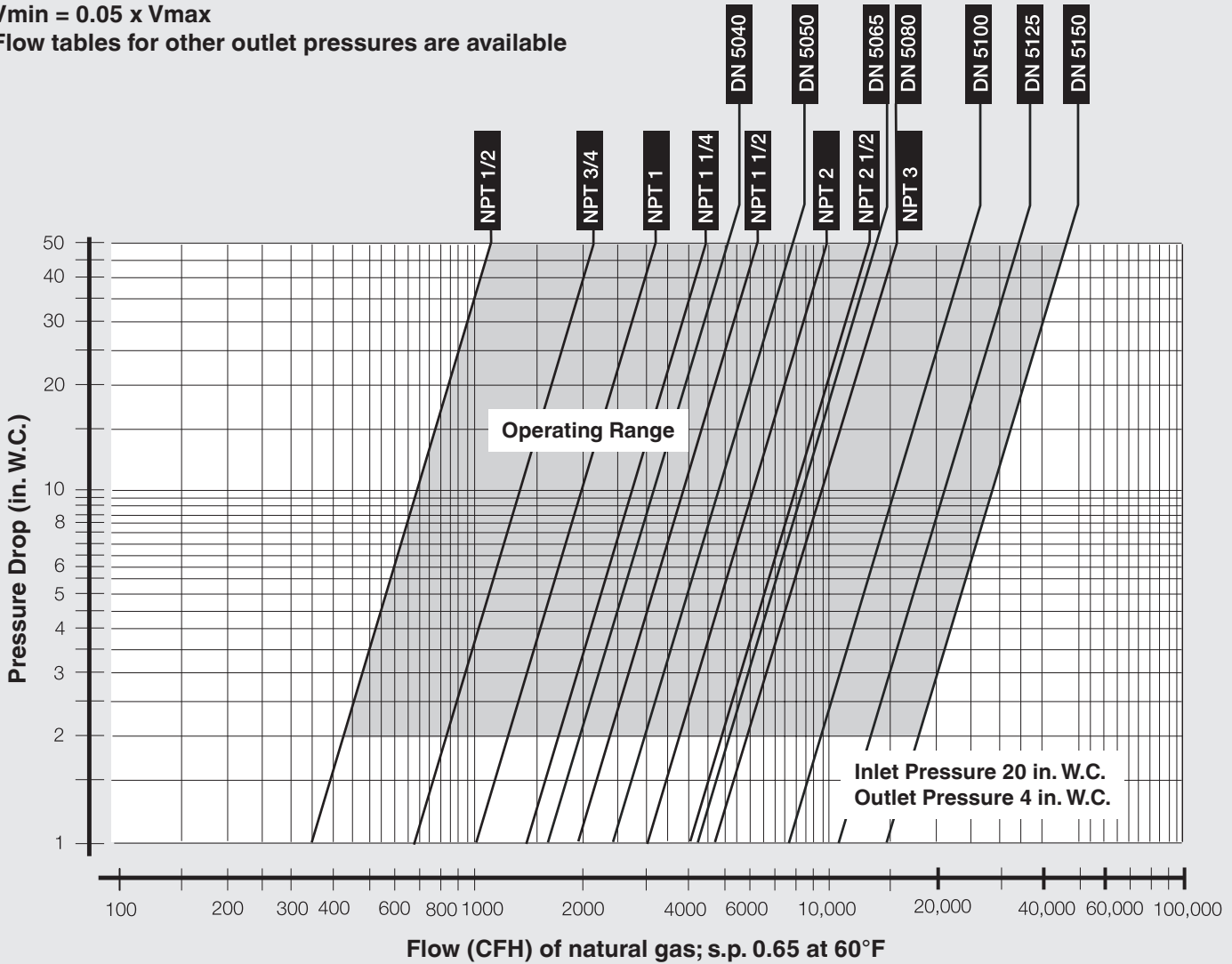

We reserve the right to make any changes in the interest of technical progress.

Karl Dungs Inc.
3890 Pheasant Ridge Drive NE
Suite 150
Blaine, MN 55449, U.S.A.
Phone 763 582-1700
Fax 763 582-1799
e-mail info@karldungsusa.com
Internet <http://www.dungs.com/usa/>

Karl Dungs GmbH & Co. KG
P.O. Box 12 29
D-73602 Schorndorf, Germany
Phone +49 (0)7181-804-0
Fax +49 (0)7181-804-166
e-mail info@dungs.com
Internet <http://www.dungs.com>